

# Zenith Aqua Sense Taps

## Zenith Automatic Taps - Deck and Wall Models.

AquaSense taps are suitable for use in Ablution troughs; Basins and Kitchen sinks

Note: Surgeon models have a 20 second run-on after use.



**Wall installation model**



**Deck installation model**



**High Neck model**

**Affix Model Number Label Here**  
**81424NZ**

**zenith**<sup>o</sup>  
instant boiling water

# Contents

|  |      |
|--|------|
| Contents . . . . .                     | 3    |
| General Fitting Instructions . . . . . | 3    |
| Components . . . . .                   | 4    |
| Installation Details . . . . .         | 4, 5 |
| Trouble Shooting . . . . .             | 6    |
| Maintenance . . . . .                  | 6, 7 |
| End of Disposal . . . . .              | 7    |
| Contact Details . . . . .              | 8    |

**NOTE:**

It is the installers responsibility to ensure the installation complies with AS/NZS3500.1, AS/NZS3500.2, AS/NZS3500.4.1, AS/NZS3500.4.2 and local water authority regulations.

## General Fitting Instructions.

### 1. Preparation

You must read these instructions thoroughly before attempting to install this tap. First check the solenoid valve supplied is suitable for the site water pressure and conditions. The standard valve requires 50kPa - 800kPa water pressure and 5° - 55° C water temperature. If your water pressure is outside the stated range please contact the manufacturer.

### 2. Pre-Fitting

First turn off the water supply. If possible select an upright position for the valve. (As shown in diagrams) check correct water flow direction when installing solenoid valve. Ensure there is sufficient room to fit the tap head assembly and enough clearance for the 1" spigot and locating peg to fit without interference. Fitting an isolation valve, in-line filter, double check valve, prior to the solenoid valve is mandatory.

### 3. Installation

Cut the pipework with tube cutters, remove sharp edges and burrs. Purge pipe work to remove all loose debris. Fit filter, isolation valve, double check valve and solenoid valve. Check all plumbing joints are secure. Take care not to over-tighten any joints. Now fit the sensor tap faucet to the required position in the worktop, sink or wall. The sensing distance for standard wall mounted tap is 150mm or 200mm for the surgeon's model. To prevent any nuisance sensing, keep a 100mm distance from sink base to Sensing Range lowest point (see fig.1 and fig.2). Secure the faucet with the nut and clamps provided.

**Important installation details for wall mount taps to avoid reflection problems.**

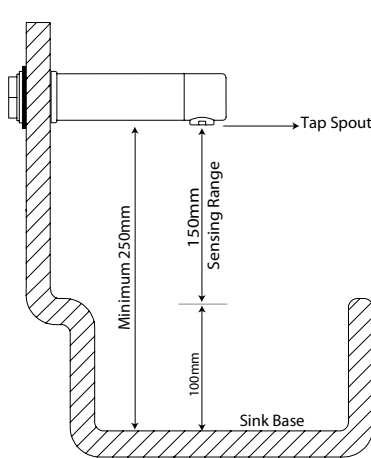

Fig.1 Standard Model

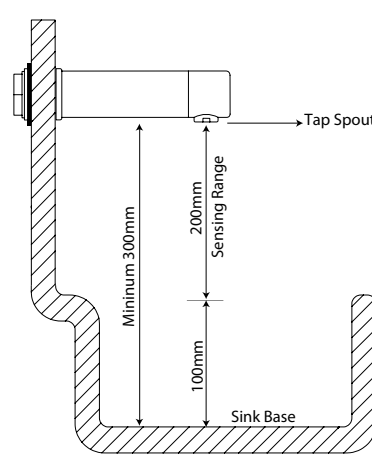

Fig.2 Surgeon Model

**Important:** where ever possible you must use the base fixing pins supplied with the faucet.

Ensure the flow restrictor in the tap outlet is adequately secured to prevent removal by hand. Firmly secure the flexible water supply hose from the faucet to the solenoid valve and turn on the water supply and check for leaks.

### 4. Plug and Socket Connections

**CAUTION:** Mount the battery box / Transformer with care, position where the risk of damage or moisture intrusion is minimal. Ensure the battery pack or powersupply is left disconnected at this stage, all cable sockets and plug connections are clean and dry. Then connect firmly and ensure that the plug and sockets are secured with the barrel nuts on the fittings.

### 5. Final Test.

Connect the battery pack or power supply unit. The sensor should now activate the solenoid when your hands are placed under the sensing area.

## Components



AC Power supply

### SUPPLIED:

1. Wall or Deck mounted Tap with fixing nut and washers.
2. AC or DC Power supply
3. 6 V DC Latching Valve
4. Brass Nipple Nut and Olive
5. JG 15mm X 1/2 BSP adapter
6. Connection Cables

### NOT SUPPLIED:

1. Isolation valve
2. Double check valve.
3. Mixing valve (optional)
4. In line filter

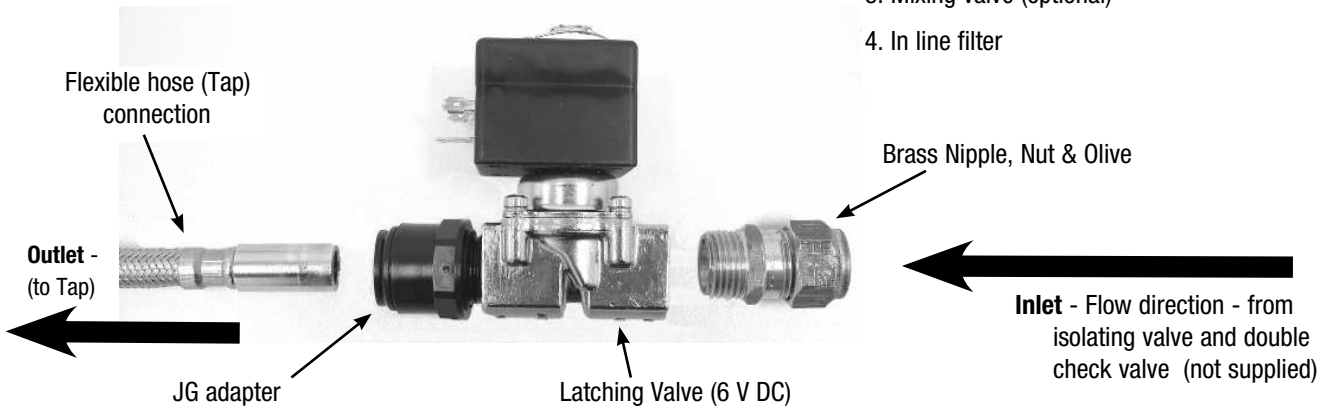

## Installation Details

### Wall installation detail

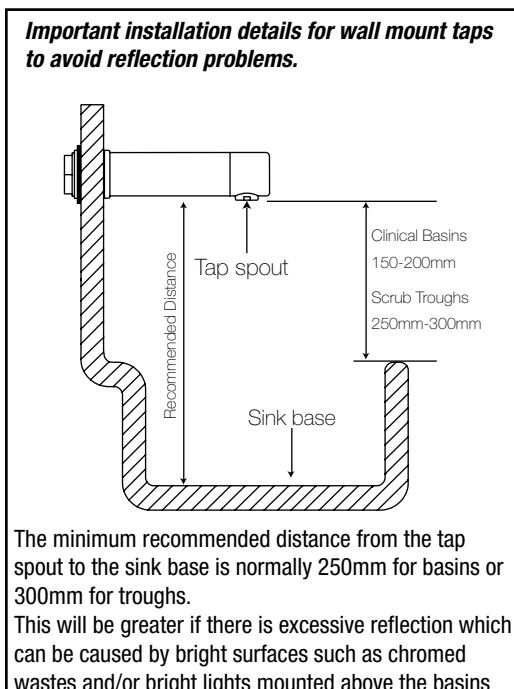

### Deck installation detail

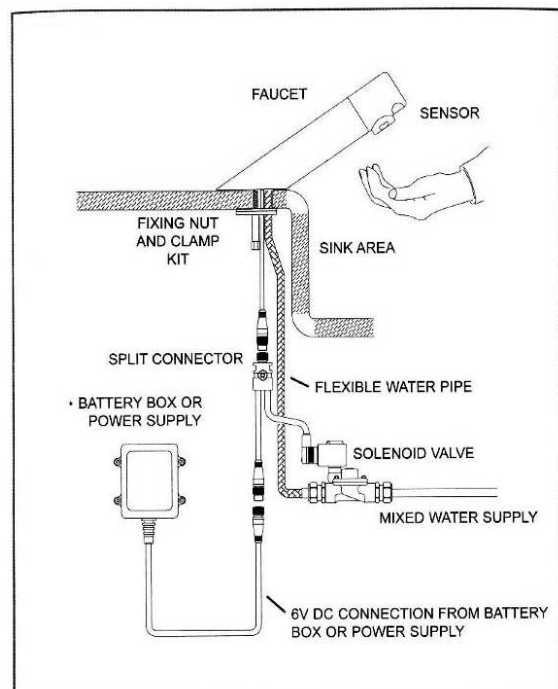

## Installation details

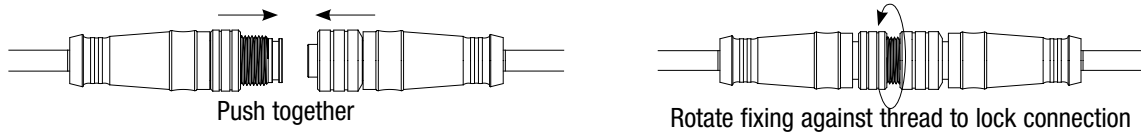

### Multi / AC mains Installation

**NOTE: You must only use the Zip power supply unit. The use of an alternative unit may cause damage.**

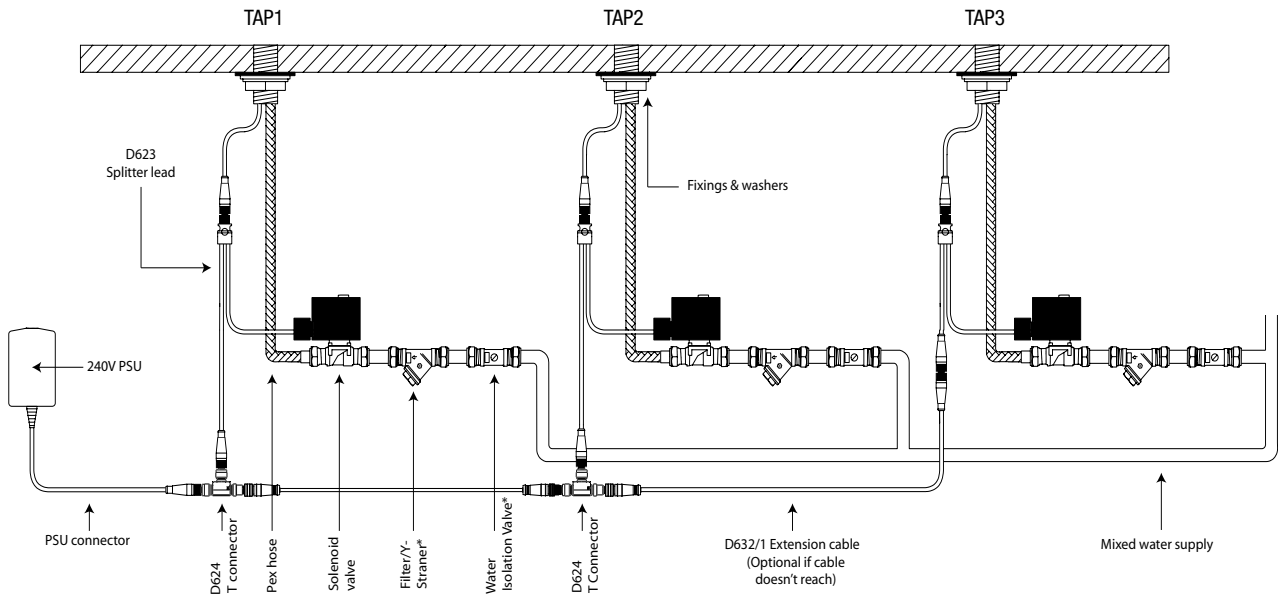

## Installation details

### Power specifications:

Input: 220 - 240 V AC

Current: 0.3 A

Freq.: 50 - 60 Hz.

Output: 6 V DC

### Instructions for Attaching Colour Coded Sticker on AquaSense Tap

Attach Colour Coded Temperature Sticker at the front face of the Tap's spout.

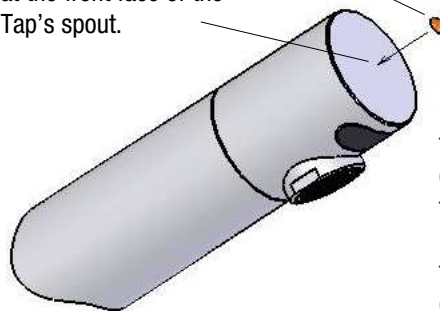

**NOTE:** Plumber must attach the appropriate colour coded sticker compliant to local Water Regulatory requirements to indicate the water temperature dispensed by the Tap.

## Trouble Shooting

| Fault   | Remedy  |
|---|---|
| Tap will not operate  | Check electrical connections, Check fuses (mains models only), Check for input voltage (6VDC), Check / Clean all connections, Check for cable damage, Dis-connect power supply and re-connect after 30 seconds, Check water is on and flowing, Check solenoid valve is fitted correctly, Check valve for operation, Check for debris in valve, Water pressure is too low / high check pressure reading. |
| Tap operates in reverse.<br>(Runs when hands are not present) | Reversed valve polarity (Contact manufacturer)  |
| Tap operates intermittently                                   | Clean sensor lens with non-abrasive material only, Tap may be installed too close to a R.F. interference source,<br>Tap may be installed too close to very bright lighting or highly reflective surroundings,<br>Water pressure may be too low for valve to operate reliably (min 50kPa required),<br>Voltage too low check output supply (power supply unit or battery, Lithium only)                  |

## Maintenance

### Valve Diaphragm Replacement:

Isolate power and water supply.

Remove fixing clip on top of latching valve coil by levering up clip with screw driver and clicking back until clip releases from shaft.

Lift coil, spring clip and spacer from latching valve shaft.

Carefully undo the 4 screws retaining the valve housing. When the last screw is about to be released, grip the valve body and top section as it is spring loaded.

Carefully separate the top section containing the spring and plungers from the lower body. The diaphragm should now be visible. Lift it out of position.

Remove the centre plastic piece from the rubber diaphragm. Fit the new diaphragm to the plastic centre. Replace it in the same orientation.

Re-assemble in the reverse of above. Note the position of all parts in the diaphragm for correct assembly. To order quote Zenith part number 90279NZ Diaphragm Kit.

The valve will require periodic cleaning and servicing. please contact Zenith for servicing.

For general cleaning do not use abrasive cleaners or materials, only use soap and water or non-abrasive cleaners.

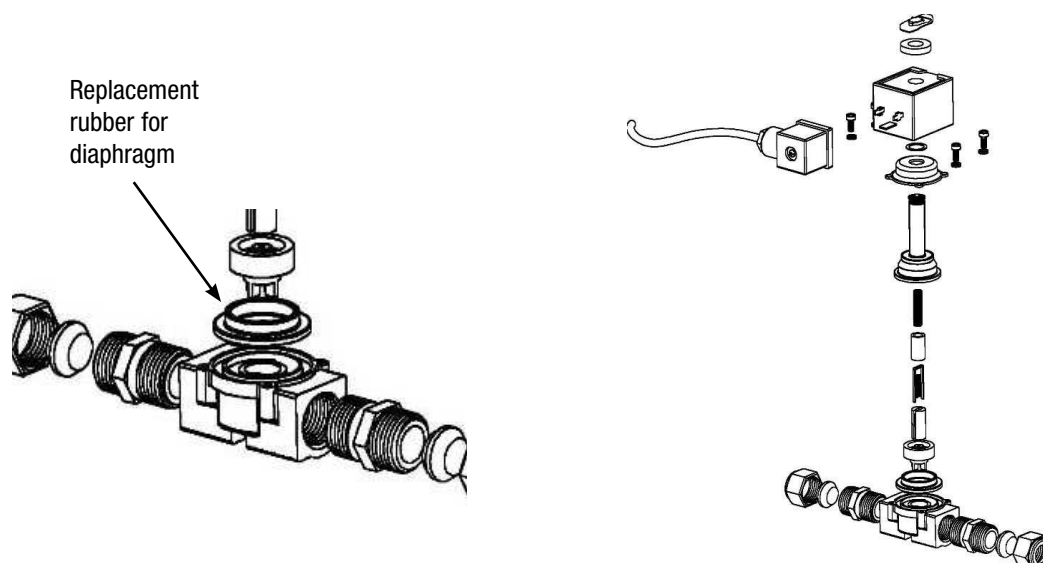

## Maintenance

Wall mounted units can be serviced by removing either of the grub screws from underneath the spout. In this way either the sensing head and/or the main body, can be removed without interfering with the wall mounted spigot. This preserves the integrity of the wall cladding (eg. Tiles / Splashbacks )



250mm Surgeons model



Wall spigot with O-ring seal

## End of Life Disposal

In order to help preserve our environment we ask that you dispose of this product correctly. Please contact your local city council for collection centre details

## Contact details

### Head Office

Zenith Heaters Limited,  
IRD No. 95 640 729  
Unit 2/15 Moselle Avenue,  
Henderson.  
Auckland. 0610  
New Zealand.

[www.zenithheaters.co.nz](http://www.zenithheaters.co.nz)

Telephone: 0800 558055  
Facsimile: 0800 559055

As Zenith policy is one of continuous product improvement, changes to specifications may be made without prior notice. Images in this booklet have been modified and may not be true representations of the finished goods.

The terms “Zenith” is a registered trade mark of Zip Heaters (Aust) Pty Ltd.

Zenith products described in this publication are manufactured under one or more of the following patents: AU675601, AU637412, AU635979, GB0422305, GB2065848, US4354049, US5103859, US5099825 and SA2006/08043. Other patents are in force and patent applications are pending.

**zenith**<sup>o</sup>  
instant boiling water